

CAIROLI



nicoline

Descrizione modello / Model Description

Dimensioni / Dimensions

Composizioni consigliate / Recommended compositions

nicoline.it

ITALY - C.da Parchi Calia sn Z.I. - 70022 Altamura - BA - Telefono: +39 080 3101487

UNITED STATES - Nicoline Salotti Inc. po box 38783 - Greensboro - NC 27438 - Phone: +1 (336) 259 9881

SINGAPORE - 23 Genting Road #06-01 - Chevalier House Singapore 349481 - Telefono: +65 8168 3354

Descrizione

Caratteristiche standard

- Struttura in legno e multistrato, molleggio seduta con cinghie elastiche.
- Imbottitura in poliuretano espanso ecologico a cellula aperta con densità differenziate, rivestito da un materassino in misto piuma.
- Rivestimento in pelle o tessuto. Tutti i rivestimenti sono fissi.
- Solo per il mercato ITALIA il rivestimento in tessuto è completamente sfoderabile.
- Piedi in materiale termoplastico nero.
- (*) Cucitura Cod.04 per rivestimento in pelle e tessuto.
- Cucitura Cod.06 sulla parte superiore della seduta e parte posteriore bracciolo solo per rivestimento in pelle .
- Inserimento letto non possibile.
- Lato componibile rifinito.
- Per tutte le versioni in tessuto sfoderabile i braccioli sono removibili con sistema a baionetta.

Caratteristiche optional su richiesta senza maggiorazione

- Disponibile con cucitura a contrasto, per la scelta del colore fare riferimento ai codici del campionario pelli.

Caratteristiche optional su richiesta con maggiorazione

- Poggiatesta (Cod.9900) con imbottitura in poliuretano espanso e supporto in metallo rivestito.
- Per il multi rivestimento il prezzo va incrementato del 7%. Per maggiori dettagli fare riferimento al paragrafo "NOTE" posto nelle prime pagine del listino.

Note

- (*) Non è possibile realizzare il rivestimento con pelli di spessore maggiore di 1.8 mm, tra cui l'articolo Nobile.
- Gli elementi Cod.6021 - 6022 sono versioni singole che non possono essere agganciate ad un elemento componibile.
- I disegni grafici che riportano l'asterisco (*) sono sempre con lato rifinito e anche agganciabili agli elementi componibili.

Description

Standard features

- Frame: wooden structure, seat suspensions in reinforced elastic webbing.
- Padding in eco-friendly open cell polyurethane foam, with different densities, covered with a mixed feather layer.
- Covering in leather or fabric. Not removable coverings.
- Legs in black thermoplastic material.
- (*) Stitching type Cod.04 for leather and fabric coverings.
- Stitching type Cod.06 on the top part of the seat and the back part of the armrest only for leather covering.
- No bed version available.
- Sectional sides finished.
- Versions with removable fabric covering are equipped with bayonet connectors for armrests only.

Optional features without any upcharge

- Contrast stitching available. Please refer to our leather collection for a thread color indication.

Optional features with upcharge

- Headrest (Cod.9900) with padding in open cell polyurethane foam and covered metal structure.
- 7% upcharge for combined coverings. Please refer to the notes at the beginning of pricelist.

Notes

- (*) Covering not available with leathers thicker than 1.8 mm, such as leather Nobile.
- Versions Cod.6021 - 6022 are free-standing and cannot be attached to modular elements.
- Versions with asterisk (*) have always the finished terminal side with the possibility to be connected to modular elements.

FRONTALE
FRONT



LATERALE
DEPTH

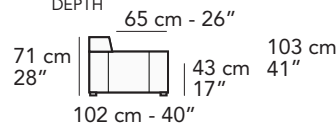

LATERALE BR BIG
BIG ARM DEPTH



3200

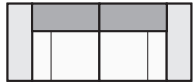

241 cm - 95"

2200

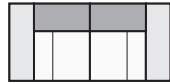

211 cm - 83"

1000



136 cm - 54"

6032

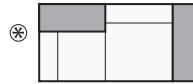

213 cm - 84"

6031



213 cm - 84"

6022

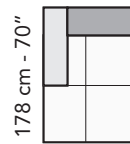

122 cm - 48"

6021

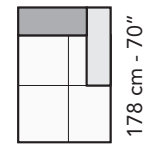

122 cm - 48"

A

1203



91 cm - 36"

1202



121 cm - 48"

1201



121 cm - 48"

3202

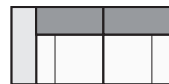

211 cm - 83"

3201

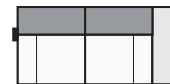

211 cm - 83"

3203

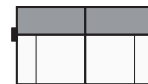

181 cm - 71"

3232



212 cm - 83"

3231



212 cm - 83"

1602

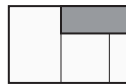

159 cm - 63"

1601



159 cm - 63"

1922



153 cm - 60"

1921

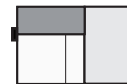

153 cm - 60"

5202



121 cm - 48"

5201

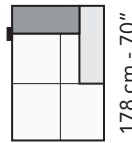

121 cm - 48"

5203

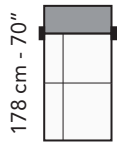

91 cm - 36"

tutti gli elementi del gruppo A hanno lo stesso modulo di seduta - all items in group A have the same seat width

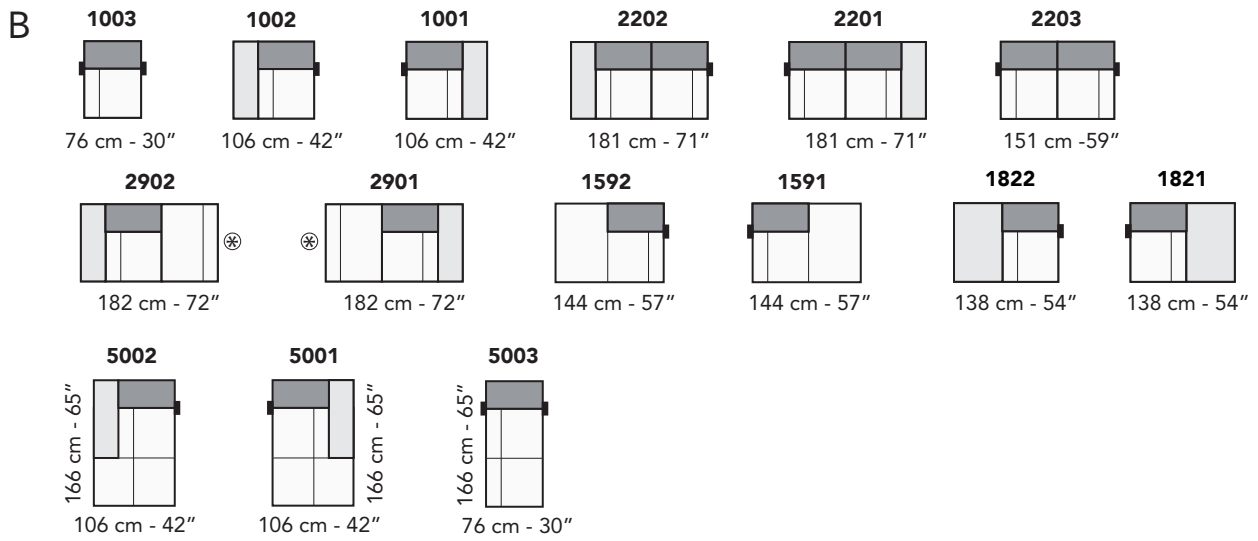

tutti gli elementi del gruppo B hanno lo stesso modulo di seduta - all items in group B have the same seat width

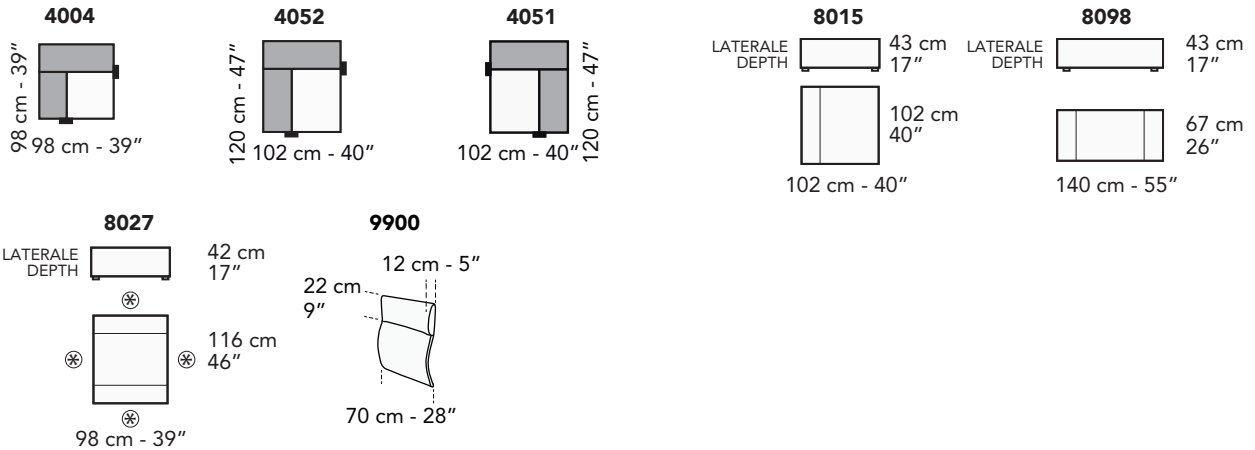

Scala 1:100 Ratio 1 to 100

Legenda / Legend

- Spalliera / Back Cushions
- Poggiareni / Kidneyrest
- Bracciolo / Armrest
- Seduta / Seat Cushions
- Marmo / Marble
- Legno / Wood
- Aggancio Componibile / Connector
- * Lato terminale sempre rifinito e agganciabile agli elementi componibili / Terminal side is always finished and it can also be connected to modular elements

Composizioni consigliate / Recommended compositions

3202 + 5201

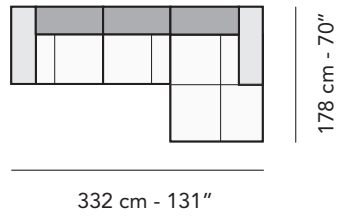

3232 + 3201

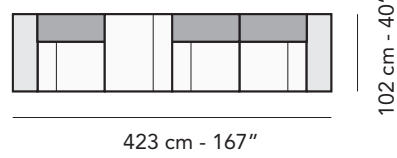

1922 + 1203 + 4052 + 6032

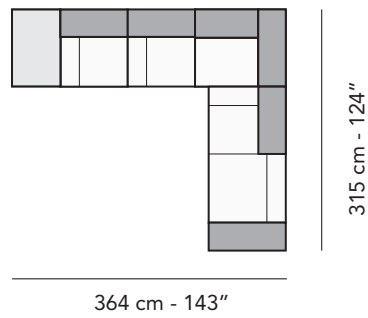



Regole Generali cosa **NON** fare.
General rules whhat **NOT** to do.

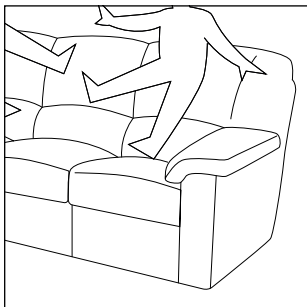

NON saltare o tuffarsi sul divano.
DO NOT jump or dive on the sofa

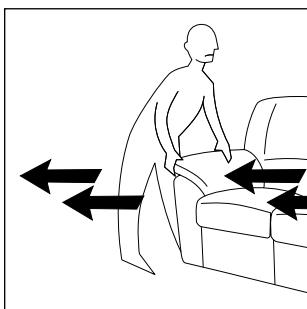

NON tirare il divano dal bracciolo.
DO NOT move the sofa from the armrest

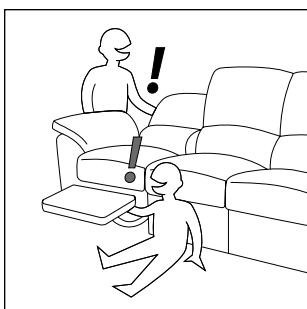

NON giocare con i meccanismi del divano.
DO NOT play with the mechanic of the sofa

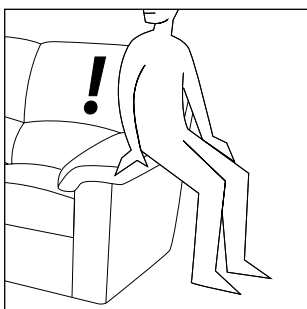

NON sedersi sui braccioli o sullo schienale
DO NOT sit on the armrest or backrest

nicoline.it