

MANZONI BIG



nicoline

Descrizione modello / Model Description

Dimensioni / Dimensions

Composizioni consigliate / Suggested compositions

nicoline.it

ITALY - C.da Parchi Calia sn Z.I. - 70022 Altamura - BA - Telefono: +39 080 3101487

UNITED STATES - Nicoline Salotti Inc. po box 38783 - Greensboro - NC 27438 - Phone: +1 (336) 259 9881

SINGAPORE - 23 Genting Road #06-01 - Chevalier House Singapore 349481 - Telefono: +65 8168 3354

Descrizione

Caratteristiche standard

- Struttura in legno e multistrato, molleggio seduta con cinghie elastiche.
- Imbottiture in poliuretano espanso ecologico a cellula aperta con densità differenziate.
- Rivestimento in pelle o tessuto. Tutti i rivestimenti sono fissi.
- Bordino "Gros grain" disponibile nei colori Cod.37 - 48 - 63 - 68 - 91 - 101 - 116 - 136 - 139 - 164 - 170 - 173.
- Piede in metallo Canna di fucile (Cod.50), Bronzo anticato (Cod.52).
- Lo schienale possiede un bottone in metallo con finitura Canna di fucile (Cod.CF).
- I cuscini di schienale sono dotati di meccanismo "pendular".
- Versioni recliner con meccanismo elettrico che permette il sollevamento della sola pediera.
- Le cuciture per il rivestimento in pelle sono realizzate nel seguente modo:
 - o Cucitura Cod.01 per parte superiore seduta e frontale spalliera;
 - o Cucitura Cod.03 per posteriore spalliera;
- Il rivestimento in tessuto non possiede cuciture.
- Inserimento letto non possibile.
- Lato componibile non rifinito.

Caratteristiche optional su richiesta senza maggiorazione

- Disponibile con cucitura a contrasto. Per la scelta del colore fare riferimento ai codici del campionario pelli.

Caratteristiche optional con maggiorazione

- Poggiatesta (Cod.9900) con imbottitura in poliuretano espanso ecologico a cellula aperta e rivestimento sfoderabile.
- Batteria al litio per movimentare il meccanismo in assenza di elettricità. Considerare una batteria per ogni seduta recliner.
- Solo per le versioni dove previsto, il lato componibile può essere rifinito.
- Per il multi rivestimento il prezzo va incrementato del 7%. Per maggiori dettagli fare riferimento al paragrafo "NOTE" posto nelle prime pagine del listino.

Note

- Le versioni contrassegnate con il simbolo "X" devono essere agganciate solamente con la versione Cod.8135 interposta fra due elementi con seduta a martello.
- I disegni grafici che riportano l'asterisco (*) sono sempre con lato rifinito e anche agganciabili agli elementi componibili.
- Non è possibile applicare altre cuciture.

Description

Standard features

- Frame: wooden structure, seat suspensions in reinforced elastic webbing.
- Paddings in eco-friendly open cell polyurethane foam with different densities.
- Covering in leather or fabric. Not removable coverings.
- Piping "Gros grain" available in colors Cod. 37 - 48 - 63 - 68 - 91 - 101 - 116 - 136 - 139 - 164 - 170 - 173.
- Legs in Gunmetal (Cod.50), Antiqued Bronze (Cod.52).
- The backrest and the padded armrest have a metal button in Gunmetal (Cod.CF).
- Back cushion with pendular mechanism on all elements.
- Recliner versions with an electrical mechanism that moves only the footrest.
- Stitchings only for the leather covering are being placed as per the following:
 - o Stitching Cod.01 for the top of the seat and frontal part of backrest;
 - o Stitching Cod.03 for the back of the backrest.
- No stitchings for the fabric covering.
- No bed version available.
- Sectional sides not finished.

Optional features available upon request with no upcharge

- Stitching, unless differently requested, will be matching the leather or fabric colour. Contrast stitching colour can be ordered at no extra charge. You might use as reference any Nicoline leather.

Optional features available upon request with an upcharge

- Headrest (Cod.9900) in eco-friendly open cell polyurethane foam and removable covering.
- Lithium battery kit available. One battery pack for each reclining seat.
- Sectional sides finished (if possible).
- 7% upcharge for combined coverings. Please refer to the notes at the beginning of pricelist.

Notes

- Versions marked with the "X" symbol can be hooked only to version Cod.8135 that is positioned between two elements with a hammer seat.
- Versions marked with (*) asterisk have always the terminal side finished with the possibility to be connected to modular elements.
- Different stitchings not available.

FRONTALE
FRONT



LATERALE
DEPTH

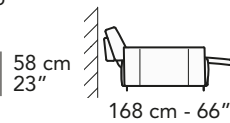
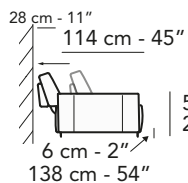
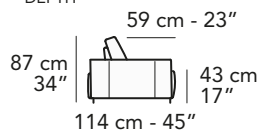

A

B 1202

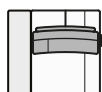

122 cm - 48"

1203



91 cm - 36"

B 1201

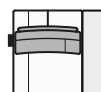

122 cm - 48"

1931

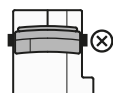

107 cm - 42"

8135

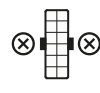

30 cm - 12"

1932

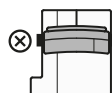

107 cm - 42"

B 1942

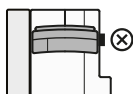

137 cm - 54"

8135

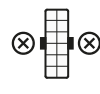

30 cm - 12"

B 1941

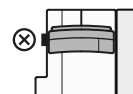

137 cm - 54"

B 1162

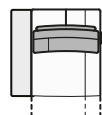

122 cm - 48"

1163

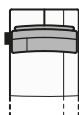

91 cm - 36"

B 1161

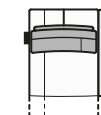

122 cm - 48"

B 5202

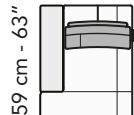

122 cm - 48"

5203

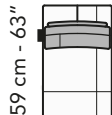

91 cm - 36"

B 5201

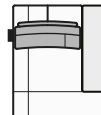

122 cm - 48"

tutti gli elementi del gruppo A hanno lo stesso modulo di seduta - all items in group A have the same seat width

nicoline

M027-MANZONI BIG

B

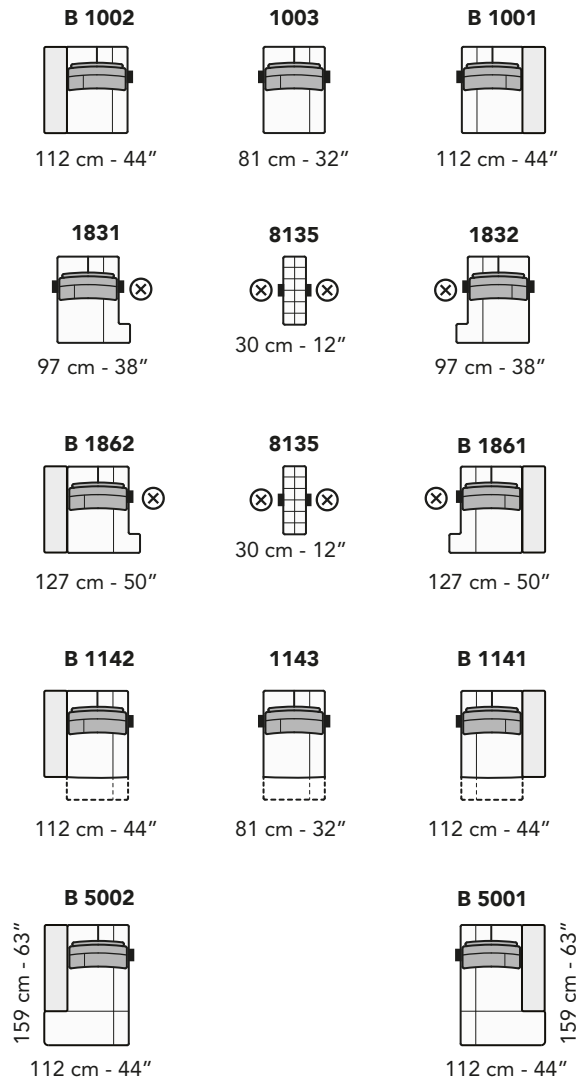

tutti gli elementi del gruppo B hanno lo stesso modulo di seduta - all items in group B have the same seat width

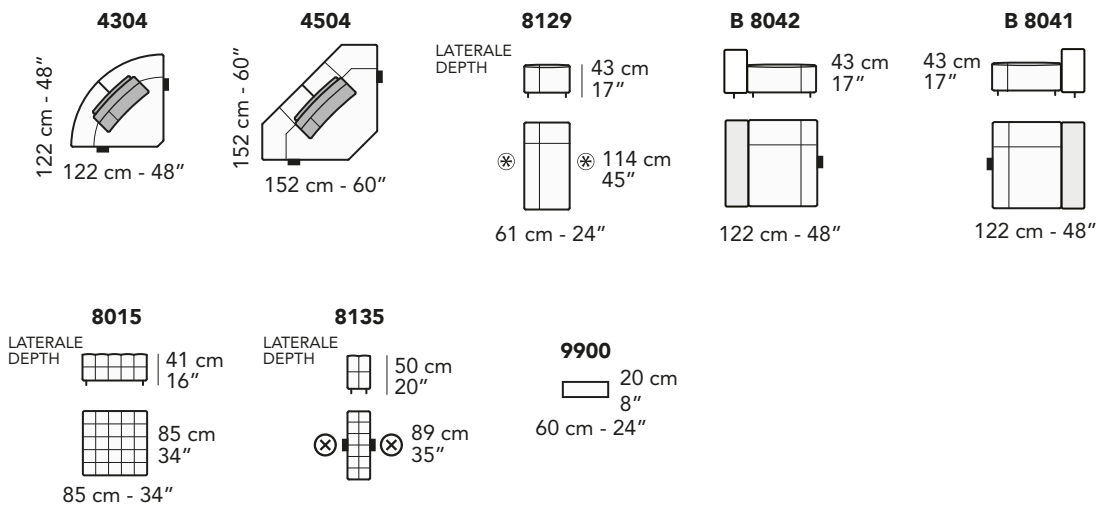

Scala 1:100
Ratio 1 to 100

Legenda / Legend

■ Spalliera / Back Cushions □ Bracciolo / Armrest
■ Poggiareni / Kidneyrest □ Seduta / Seat Cushions

⊗ Lato terminale sempre rifinito e agganciabile agli elementi componibili / Terminal side is always finished and it can also be connected to modular elements

■ Aggancio Componibile / Connector
⊗ Lato agganciabile obbligatoriamente con la versione 8135/ Side that can only be connected with version 8135

Composizioni consigliate / Suggested compositions

B1202 + 1203 + B5201

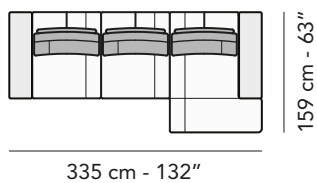

B1202 + 1203 + 4504 + 1203 + 8129

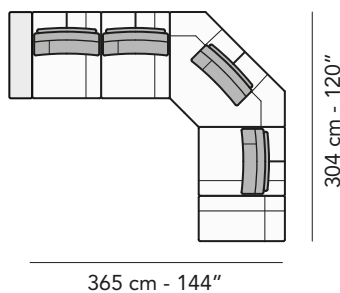

B8042 + 1203 + 4304 + 1203 + B1201

